

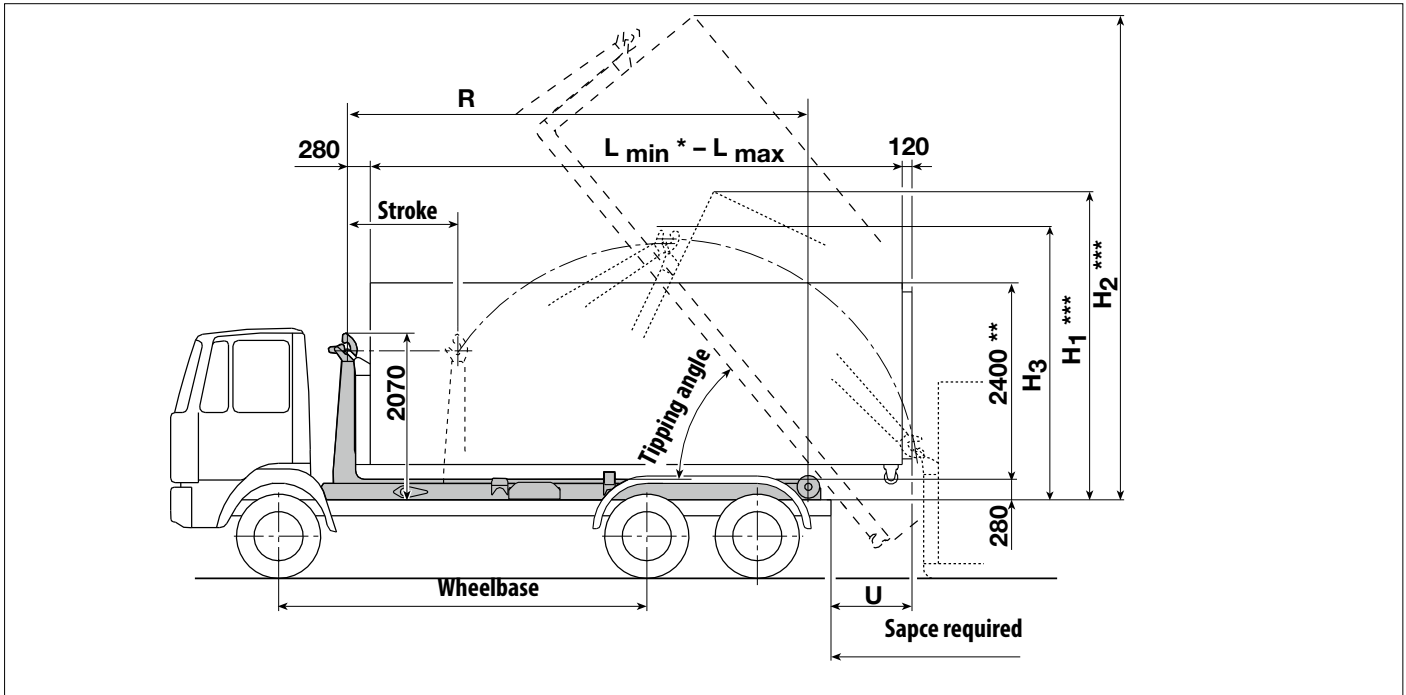

Hooklift RK 26.62 K - RK 26.70 K

(according to DIN 30 722-2)



Technical Data

Technically admissible payload max. 26.000 kg
 incl. container
 Effective payload 18.000 – 26.000 kg
 incl. container (depending on the chassis)
 for chassis with a permissible g.v.w. from 28.000 kg

Hydraulic system:

Pump flow rate at 1 115 r.p.m. 105 l/min
 Oil tank capacity (effective) 50 l
 Capacity of the entire hydraulic system 155 l

Operating time:

a) Setting down 21 – 33 s
 b) Tipping 33 – 39 s
 c) Picking up / lowering 44 s

Containers according to DIN 30 722-2

with strap height 1.570 mm
 optional 1.370 – 1.480 mm
 Max. container width according to StVZO 2.550 mm
 See Container data sheet 0395 0651 033 page 1
 Mobile compactors according to DIN 30 730
 Special containers by arrangement.

RK K	26.62	26.65	26.67	26.70				
max. container length "L" [mm] standard	6250	6500	6750	7000				
min. container length "L" [mm] *	4750	5000	5250	5500				
Stroke [mm]	1100	1225	1225	1350				
Hooklift length "R" [mm]	5490	5615	5865	6115				
Tipping angle	55°	55°	52°	52°				
Container overhang "U" [mm]	990	990	990	990				
"H ₁ " Setting down the container [mm] ***	3840	3850	3860	3970				
"H ₂ " Container tipped [mm] ***	5920	6030	6150	6350				
"H ₃ " Clearance zone radius of jib min. [mm]	3500	3500	3500	3600				
Space required [mm]	7900	8000	8000	8350				
Wheelbase approx. [mm]	4200 - 4500	4500	4500 - 4800	4800				
Weight [kg] ****	3050	3055	3100	3150				
max. operating pressure [bar]	300	300	300	320				
Power consumption of the pump at max. pressure [kW]	53	53	53	56				
Required driving torque of the pump max. pressure [Nm]	452	452	452	482				
Operating time for pushing forward the container at full stroke [s]	9	9	9	10				
Operating time for pushing back the container at full stroke [s]	9	9	9	10				

* Tipping is only possible with limitations due to the short container overhang.
 ** The maximum container height is dependent on the vehicle and should be chosen such that, in accordance with the German Motor Vehicle Construction and Use Regulations, the overall height of 4 000 mm is not exceeded when the vehicle is unloaded.
 *** The heights are based on a container height of 2 400 mm.
 **** Weight without oil tank, pump, fixing parts, mud guards, additional equipment such as under-ride guard, axle support, internal locking mechanism, etc. Excess weights depending on the chassis.
 Exact dimensions and weights will be given, once a chassis has been chosen. For suitable chassis see lists of recommended vehicles.

Subject to modification due to new developments!